



SERIES: DECISIONS THAT HEAL

THE DECISION TO LOVE

Jesus replied: " 'Love the Lord your God with all your heart and with all your soul and with all your mind.' This is the first and greatest commandment. And the second is like it: 'Love your neighbor as yourself.'

Matthew 22:37-39

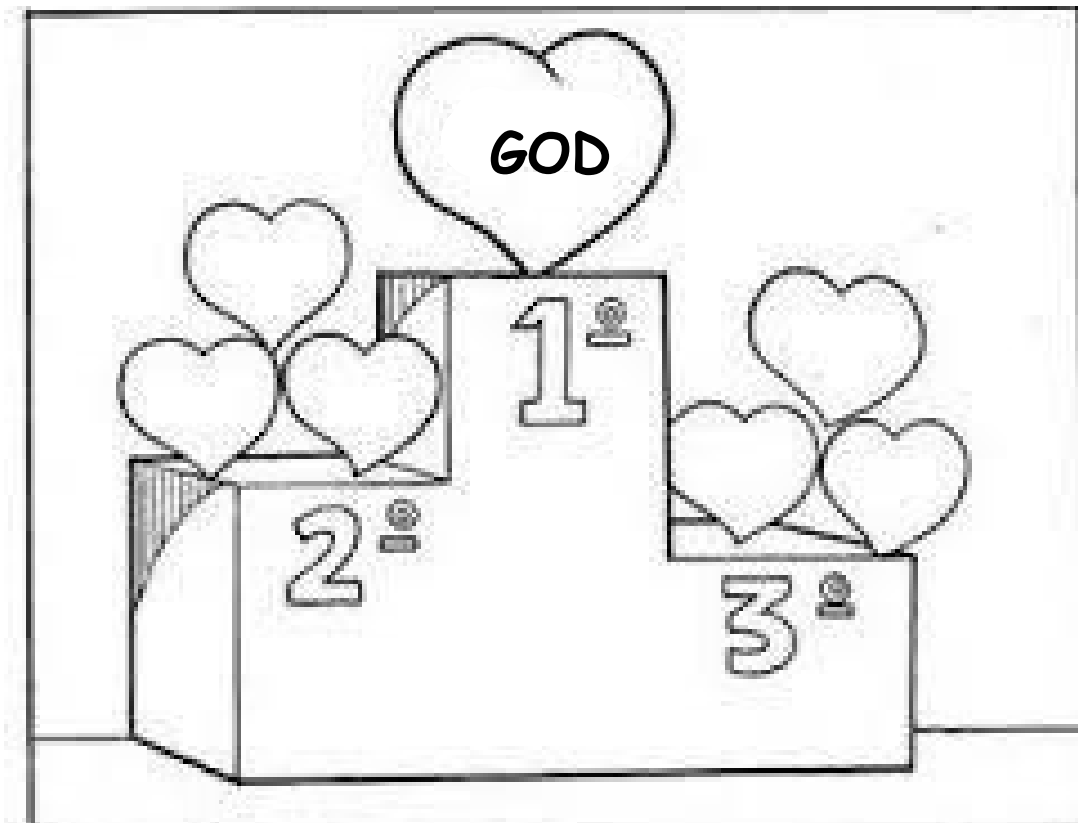

Today we are going to talk about something very important: love. Jesus says that loving God and others is the most important thing in our lives. Let's learn how to make the decision to love!



Loving God

With all our heart: This means that we love God very much and that we put God as the most important part of our lives. **With all our soul:** This means that our whole life is dedicated to God. We want to be close to Him always.

With all our mind: This is using our head to learn more about God, read the Bible, and think about His teachings.

Obeying God: Loving God also means doing what He asks of us and trusting in His plans for us.

Love others

Showing care: We help and support others when they need it.

Forgiving and reconciling: When someone hurts us, it is important to forgive and try to resolve the problems.

Serving: We do kind things for others without expecting anything in return.



Loving Ourselves

Self-Care: This means accepting who we are and taking healthy care of ourselves.

Identity in Christ: Remembering that we are special to God helps us feel good about ourselves.

Balance: It's okay to ask for help and accept love from others when we need it.

Benefits of Love

Closeness to God: Loving God brings us closer to Him and helps us feel His guidance and presence.

Healing the Heart: Love can help us feel better when we are sad or hurt.

Better Relationships: Love makes our friendships stronger and longer lasting.

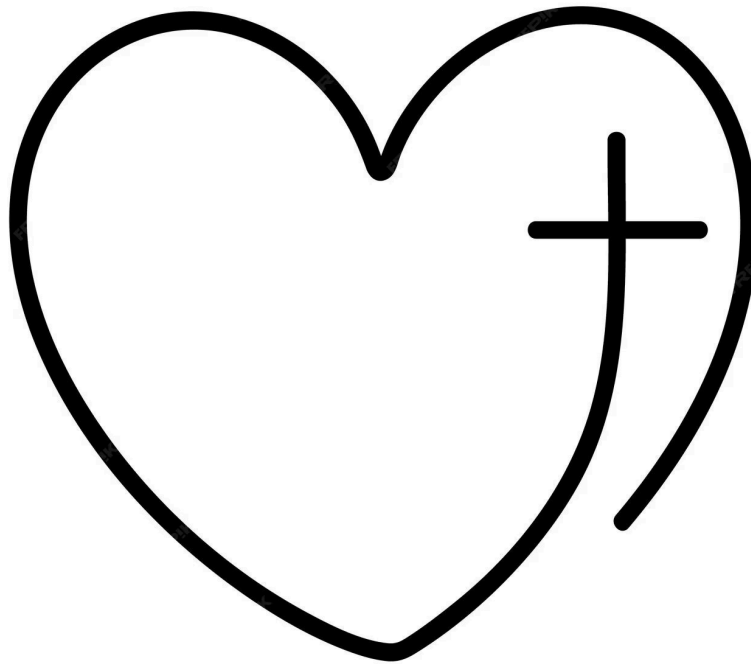

Today, decide to love God, others, and yourself. Let God's love shine in your life and you will see how everything changes for the better. Ask God to fill you with His love and help you love as He does.

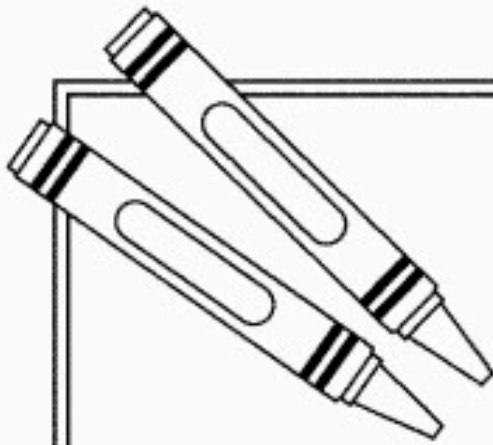

Just for **KIDS**

Find the correct path through the heart below. Write the words in order, as you find them, on the lines below.

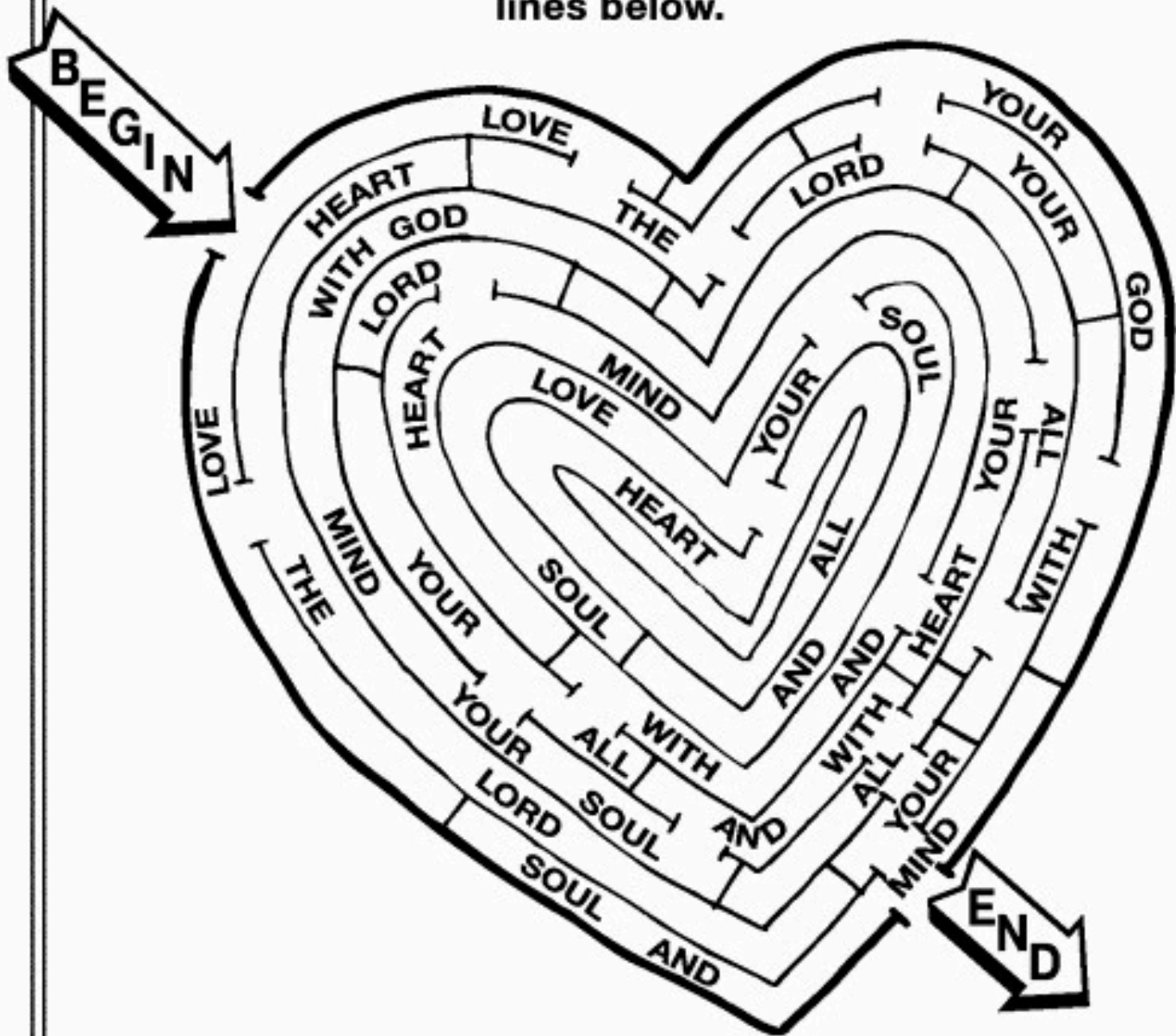





“ _____

5 _____.” Matthew 22:37

Love Word Search

1 Corinthians 13:4-8

Find the hidden words.



K Y D S N G E G I P B E E E H
U P A E M L G A A V E A B O N
W R T V Q F P R R J A T P W E
U E I E Z J R B R Z R E O P Z
U N R I G H T E O U S N E S S
N E B L B Q P P G F M H C J K
N S Q E K E R S A V P P R P X
E J E B C O P T N C M L C X Q
R N S C V O N E T N X J J T C
D P D O I E M D E R E F F U S
Y N K U I O R I J E A L O U S
R E I T R D J O N F L C G V K
D R A K F E Z E A G X M K O F
Z P Y Z D A S R R R L S R A W
Q T K X B W R E V E N Y Y C N

Is **PATIENT**

Is **KIND**

Is Not **JEALOUS**

Does Not **BRAG**

Is Not **ARROGANT**

Does Not Act **UNBECOMINGLY**

Does Not Seek Its **OWN**

Is Not **PROVOKED**

Does Not Take Into Account A
Wrong **SUFFERED**

Does Not Rejoice In
UNRIGHTEOUSNESS

REJOICES With The Truth

BEARS All Things

BELIEVES All Things

HOPES All Things

ENDURES All Things

Notes:

Name: _____

Date: _____

